

ORDER INFORMATION AND DIMENSION:

Circuits	Part No. (Matte tin-plated)	Dimension	
		A	B
2	3001P02 19V	3.00	9.7
3	3001P03 19V	6.00	12.7
4	3001P04 19V	9.00	15.7
5	3001P05 19V	12.00	18.7
6	3001P06 19V	15.00	21.7
7	3001P07 19V	18.00	24.7
8	3001P08 19V	21.00	27.7
9	3001P09 19V	24.00	30.7
10	3001P10 19V	27.00	33.7
11	3001P11 19V	30.00	36.7
12	3001P12 19V	33.00	39.7

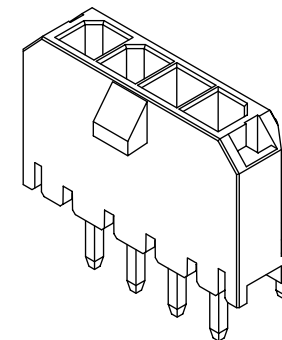
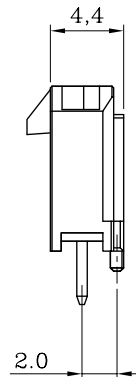
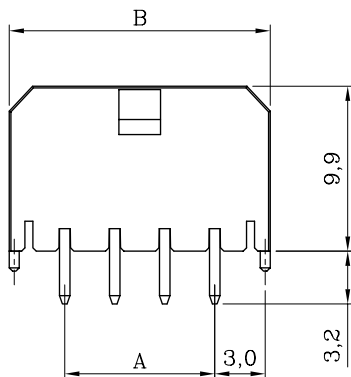
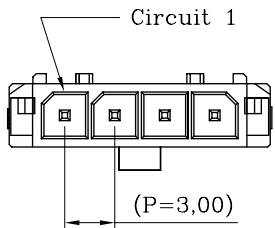

ISOMETRIC VIEW

DESCRIPTION OF ORDER NO.:

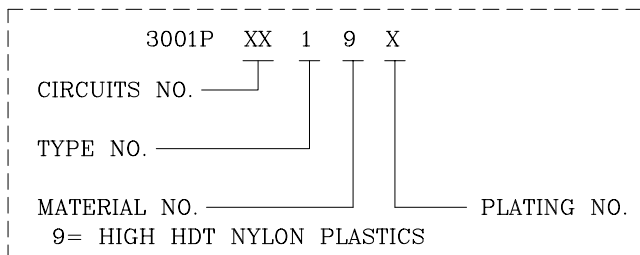

NOTES:

- MATERIAL:
BASE: HIGH HDT NYLON 94V-0, BLACK COLOR
CONTACT PIN: BRASS
- MATES WITH 3000F SINGLE-ROW SERIES PLUG HOUSING.
- DESCRIPTION OF COLOR CODE:
LEGEND: 3001PXX19X-X (-X: COLOR CODE)
R=RED, E=BLUE, H=GRAY, M=GREEN, S=IVORY (NATURAL)
I=BRICK RED,
- REPLACEMENT OF HALOGEN-FREE PRODUCT:
LEGEND: 3001PXX19X-XNH (NH: HALOGEN-FREE)
LEGEND: 3001PXX19X-BNH (B=BLACK COLOR)
- INFORMATION IN THIS DRAWING IS NOT CONSIDERED AS FINAL.

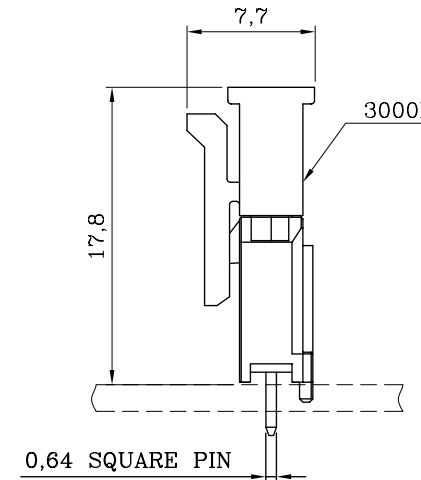
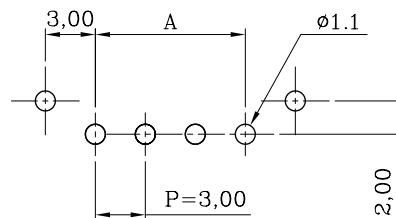

ASSEMBLY LAYOUT

P.C. BOARD LAYOUT
(COMPONENT SIDE)



GWT 850 °C Rated

Sales Drawing

MATERIAL: SEE NOTES

FINISH(COLOR): SEE NOTES

LANDWIN 聯盈電子股份有限公司
LANDWIN ELECTRONIC CORP.

GENERAL TOLERANCE:	PROJECTION	SCALE	UNIT	SHEET NO.	REV
	⊕	FREE	MM	1 / 1	W1

DRAWN	R.G.	DRAW NO.
CHECKED	J.L.Lin	(CQ) 3001PXX19X

APPD	H.Y.Lin	TITLE:
------	---------	--------

W1	NEW RELEASE	31-DEC-14'	ANGULAR ±3°	DATE 31-DEC-14'	3.00 PITCH SINGLE-ROW S/T HEADER (TYPE-1)
REV.	REVISION RECORD	DATE			

DESCRIPTION OF PLATING CODE:	
V= MATTE TIN-PLATED	A= SELECT GOLD FLASH-PLATED