

ORDER INFORMATION AND DIMENSION:

Circuits	Part No. (PA66 94V-0, White color, T/P) (Circuit No.2 Void)	Dimension	
		A	B
2	3061P0202T-SN02	3.96	7.92
3	3061P0302T-SN02	7.92	11.88
4	3061P0402T-SN02	11.88	15.84
5	3061P0502T-SN02	15.84	19.80
6	3061P0602T-SN02	19.80	23.76
7	3061P0702T-SN02	23.76	27.72
8	3061P0802T-SN02	27.72	31.68
9	3061P0902T-SN02	31.68	35.64
10	3061P1002T-SN02	35.64	39.60
11	3061P1102T-SN02	39.60	43.56
12	3061P1202T-SN02	43.56	47.52
13	3061P1302T-SN02	47.52	51.48
14	3061P1402T-SN02	51.48	55.44
15	3061P1502T-SN02	55.44	59.40

DESCRIPTION OF ORDER NO.:

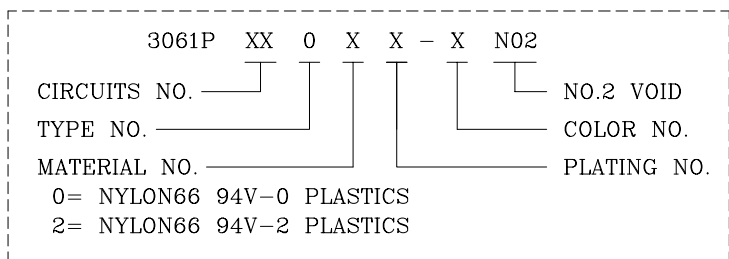

NOTES:

- MATERIAL:
BASE: NYLON66 94V-0/94V-2, WHITE COLOR (NATURAL)
CONTACT PIN: BRASS
- MATES WITH 3060SXXAX SERIES PLUG HOUSING.
- DESCRIPTION OF COLOR NO:
LEGEND: 3061PXX0XX-XN02 (-X: COLOR CODE)
B=BLACK, C=COCONUT BROWN, E=BLUE, H=GRAY,
I=BRICK RED, M=GREEN, R=RED, W=BROWN
- INFORMATION IN THIS DRAWING IS NOT CONSIDERED AS FINAL.

DESCRIPTION OF PLATING NO:	
T= TIN-PLATED (T/P)	1= GOLD FLASH-PLATED
V= MATTE TIN-PLATED	

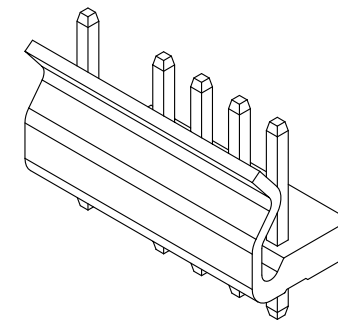
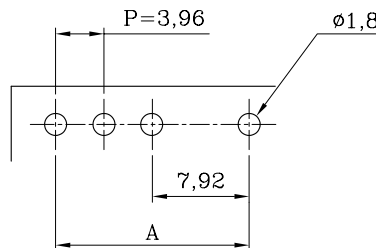
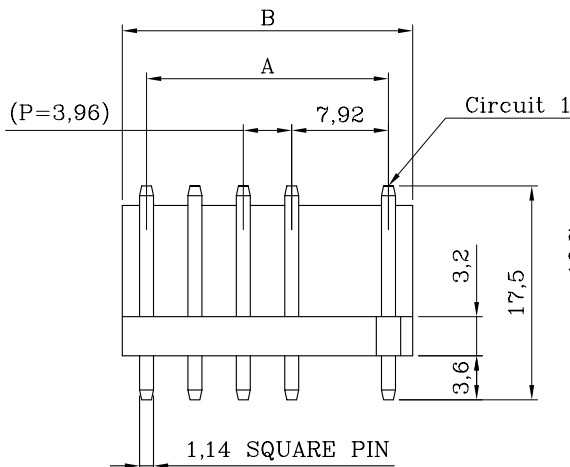
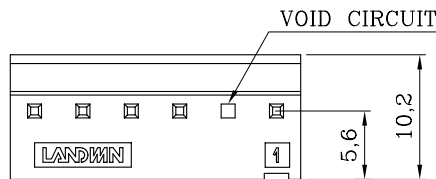

ISOMETRIC VIEW

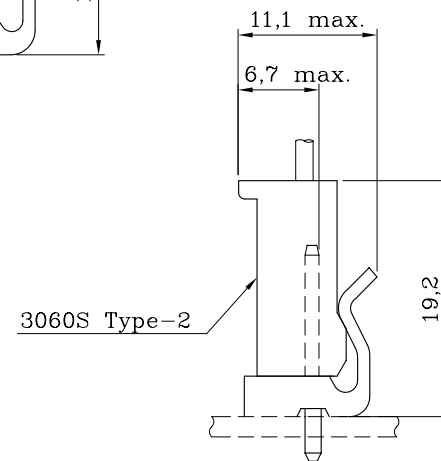
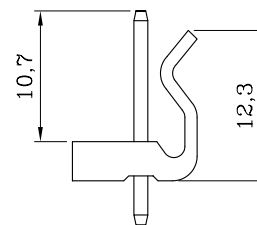

ASSEMBLY LAYOUT

P.C. BOARD LAYOUT
(COMPONENT SIDE)

MATERIAL: SEE NOTES		FINISH(COLOR): SEE NOTES	
W1	NEW RELEASE	31-DEC-14'	ANGULAR $\pm 3^\circ$
REV.	REVISION RECORD	DATE	



Sales Drawing

LANDWIN 聯盈電子股份有限公司
LANDWIN ELECTRONIC CORP.

GENERAL TOLERANCE:	PROJECTION	SCALE	UNIT	SHEET NO.	REV
		FREE	MM	1 / 1	W1
	DRAWN R.G.	DRAW NO.			
	CHECKED J.L.Lin	(CQ) 3061PXX0XX-XN02			
	APPD H.Y.Lin	TITLE:			
	DATE 31-DEC-14'	3.96 PITCH SINGLE-ROW S/T HEADER (PIN-2 VOID)			