

ORDER INFORMATION AND DIMENSION:

Circuits	Part No. (White color, T/P) (Without Peg)	Dimension	
		A	B
2	3062P02A0T	3.96	7.92
3	3062P03A0T	7.92	11.88
4	3062P04A0T	11.88	15.84
5	3062P05A0T	15.84	19.80
6	3062P06A0T	19.80	23.76
7	3062P07A0T	23.76	27.72
8	3062P08A0T	27.72	31.68
9	3062P09A0T	31.68	35.64
10	3062P10A0T	35.64	39.60
11	3062P11A0T	39.60	43.56
12	3062P12A0T	43.56	47.52
13	3062P13A0T	47.52	51.48
14	3062P14A0T	51.48	55.44
15	3062P15A0T	55.44	59.40

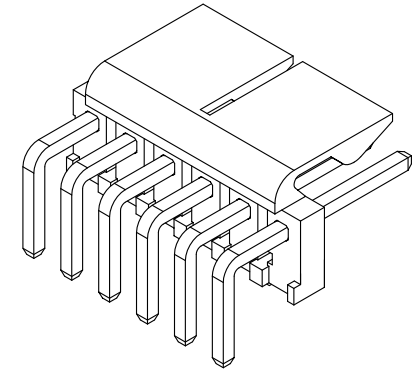
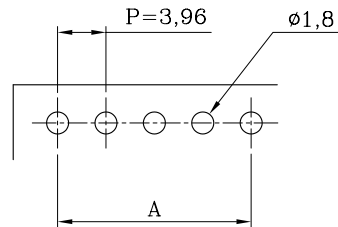
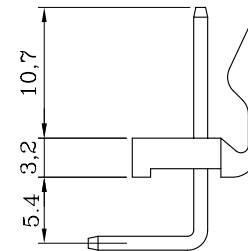
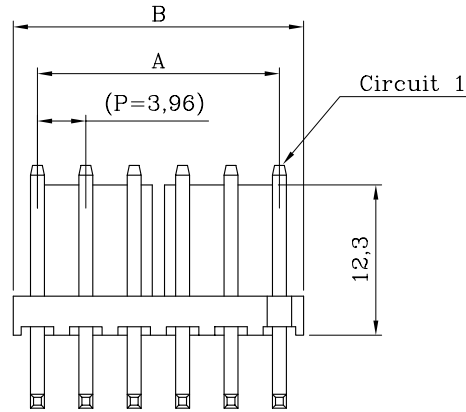
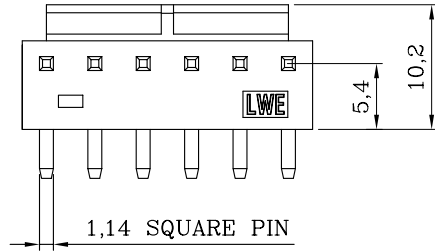

ISOMETRIC VIEW

DESCRIPTION OF ORDER NO.:

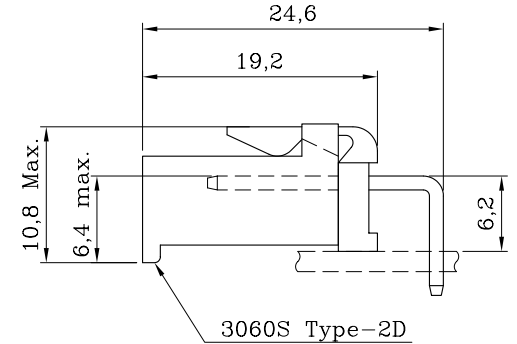
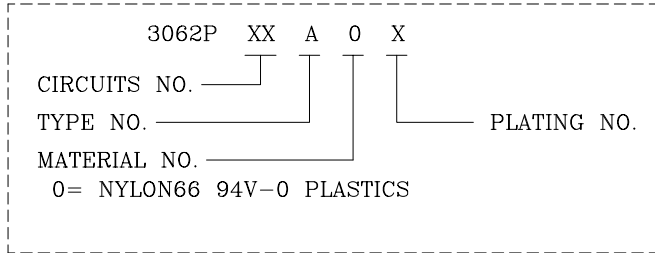

NOTES:

- MATERIAL:  
BASE: NYLON66 94V-0, WHITE COLOR (NATURAL)  
CONTACT PIN: BRASS
- MATES WITH PLUG HOUSING: 3060SXX0X, 3060SXX2X,  
3060SXX2X-SC, 3060SXX2X-SD, 3060SXXCX, 3060SXXDX.
- DESCRIPTION OF COLOR NO:  
LEGEND: 3062PXXA0X-X (-X: COLOR CODE)  
B=BLACK, C=COCONUT BROWN, E=BLUE, H=GRAY,  
I=BRICK RED, M=GREEN, R=RED, W=BROWN
- INFORMATION IN THIS DRAWING IS NOT CONSIDERED AS FINAL.

DESCRIPTION OF PLATING NO:	
T= TIN-PLATED (T/P)	1= GOLD FLASH-PLATED
V= MATTE TIN-PLATED	

P.C. BOARD LAYOUT  
(COMPONENT SIDE)

MATERIAL: SEE NOTES	
FINISH(COLOR): SEE NOTES	
W1	NEW RELEASE
REV.	REVISION RECORD



Sales Drawing



聯盈電子股份有限公司  
LANDWIN ELECTRONIC CORP.

GENERAL TOLERANCE:	PROJECTION	SCALE	UNIT	SHEET NO.	REV
	⊕	FREE	MM	1 / 1	W1
	DRAWN	R.G.	DRAW NO.		
	CHECKED	J.L.Lin	(CQ) 3062PXXA0X		
	APPD	H.Y.Lin	TITLE:		
W1	NEW RELEASE	31-DEC-14'	ANGULAR ±3°	DATE 31-DEC-14'	3.96 PITCH SINGLE-ROW R/A HEADER (TYPE-A)
REV.	REVISION RECORD	DATE			