

ORDER INFORMATION AND DIMENSION:

Circuits	Part No. (PA66 94V-2, White color)	Dimension	
		A	B
2	3162P0202T	3.96	7.92
3	3162P0302T	7.92	11.88
4	3162P0402T	11.88	15.84
5	3162P0502T	15.84	19.80
6	3162P0602T	19.80	23.76
7	3162P0702T	23.76	27.72
8	3162P0802T	27.72	31.68
9	3162P0902T	31.68	35.64
10	3162P1002T	35.64	39.60
11	3162P1102T	39.60	43.56
12	3162P1202T	43.56	47.52
13	3162P1302T	47.52	51.48
14	3162P1402T	51.48	55.44
15	3162P1502T	55.44	59.40

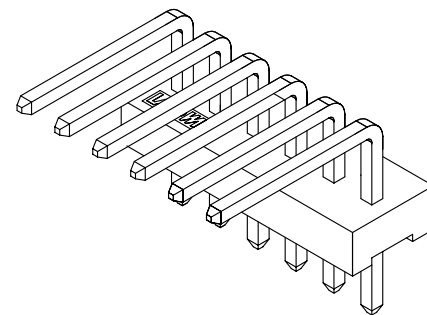
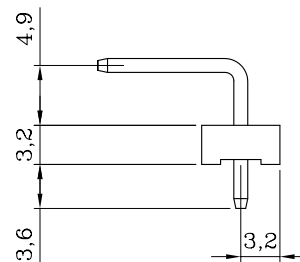
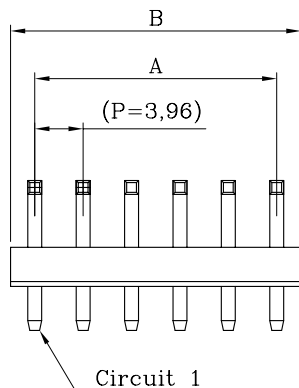
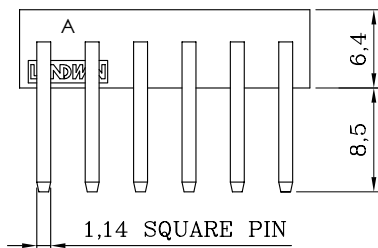

ISOMETRIC VIEW

DESCRIPTION OF ORDER NO.:

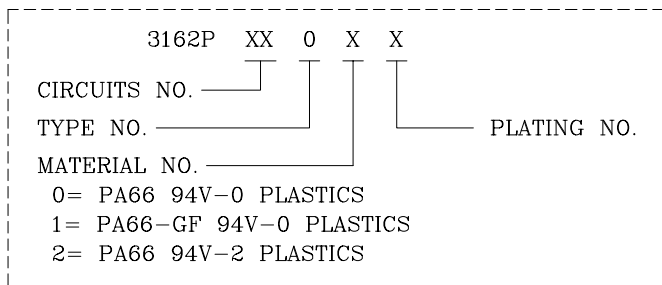

NOTES:

- MATERIAL:  
BASE: PA66 94V-0/94V-2, WHITE COLOR (NATURAL)  
BASE (No.=1): PA66-GF 94V-0, LIGHT IVORY COLOR (NATURAL)  
CONTACT PIN: BRASS
- MATES WITH 3060SXX1X, 3060SXXXNX SERIES PLUG HOUSING.
- DESCRIPTION OF COLOR NO:  
LEGEND: 3162PXX0XX-X (-X: COLOR CODE)  
B=BLACK, C=COCONUT BROWN, E=BLUE, H=GRAY,
- REPLACEMENT OF HALOGEN-FREE PRODUCT (PA66-GF BASE):  
LEGEND: 3162PXX01X-XNH (NH: HALOGEN-FREE)  
LEGEND: 3162PXX01X-SNH (S=LIGHT IVORY COLOR)
- INFORMATION IN THIS DRAWING IS NOT CONSIDERED AS FINAL.

DESCRIPTION OF PLATING NO:	
T= TIN-PLATED (T/P)	1= GOLD FLASH-PLATED
V= MATTE TIN-PLATED	

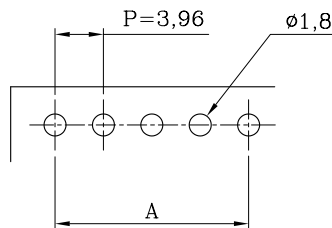

P.C. BOARD LAYOUT  
(COMPONENT SIDE)

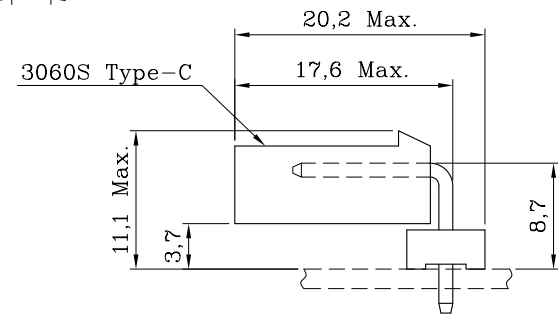

ASSEMBLY LAYOUT

MATERIAL: SEE NOTES		FINISH(COLOR): SEE NOTES	
W1	NEW RELEASE	31-DEC-14'	ANGULAR ±3°
REV.	REVISION RECORD	DATE	

		Sales Drawing			
聯盈電子股份有限公司 LANDWIN ELECTRONIC CORP.					
GENERAL TOLERANCE:	PROJECTION	SCALE	UNIT	SHEET NO.	REV
		FREE	MM	1 / 1	W1
	DRAWN R.G.	DRAW NO.			
	CHECKED J.L.Lin	(CQ) 3162PXX0XX			
	APPD H.Y.Lin	TITLE:			
		DATE 31-DEC-14'	3.96 PITCH SINGLE-ROW R/A HEADER		