

ORDER INFORMATION AND DIMENSION:

Circuits	Part No. (PA66 94V-0) (WHITE COLOR)	Dimension	
		A	B
4	66775P04 B0T	6.2	13.4
6	66775P06 B0T	12.4	19.6
8	66775P08 B0T	18.6	25.8
10	66775P10 B0T	24.8	32.0
12	66775P12 B0T	31.0	38.2

Circuits	Part No. (PA66-GF PLASTICS) (LIGHT IVORY COLOR)	Dimension	
		A	B
4	66775P04 B1T	6.2	13.4
6	66775P06 B1T	12.4	19.6
8	66775P08 B1T	18.6	25.8
10	66775P10 B1T	24.8	32.0
12	66775P12 B1T	31.0	38.2

DESCRIPTION OF ORDER NO.:

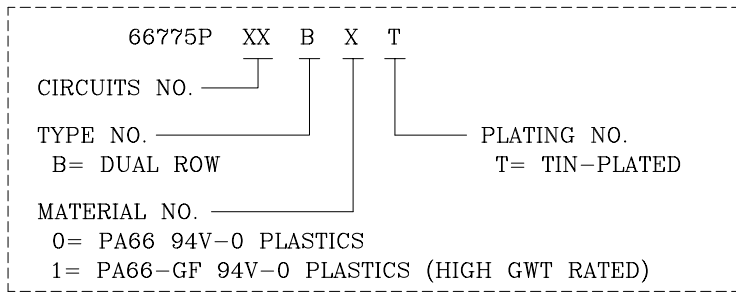

NOTES:

- MATERIAL:  
 BASE (No.=0): PA66 94V-0, WHITE  
 BASE (No.=1): PA66-GF 94V-0, LIGHT IVORY COLOR  
 CONTACT PIN: PHOSPHOR BRONZE, TIN-PLATED
- MATES WITH 66774FXXBX TYPE-B SERIES PLUG HOUSING.
- DESCRIPTION OF COLOR NO.:  
 LEGEND: 66775PXXBXT-X (-X: COLOR NO.)  
 B=BLACK, E=BLUE, H=GRAY,  
 I=BRICK RED, R=RED, W=BROWN
- REPLACEMENT OF HALOGEN-FREE PRODUCT (PA66-GF PLASTICS):  
 LEGEND: 66775PXXB1T-XNH (NH: HALOGEN-FREE)  
 LEGEND: 66775PXXB1T-SNH (S=LIGHT IVORY /NATURAL COLOR)
- INFORMATION IN THIS DRAWING IS NOT CONSIDERED AS FINAL.

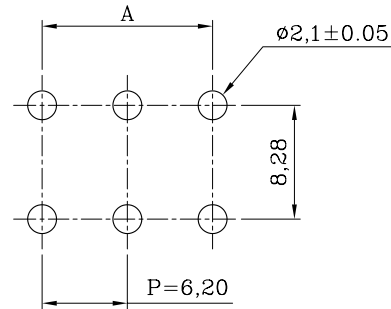
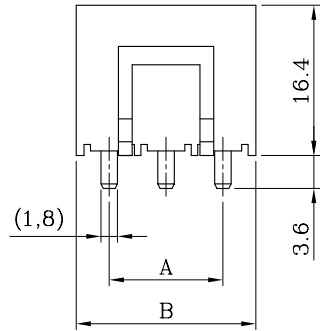
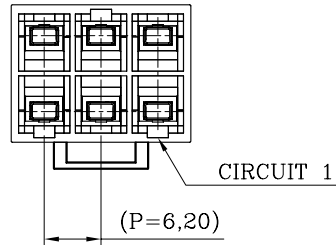

P.C. BOARD LAYOUT

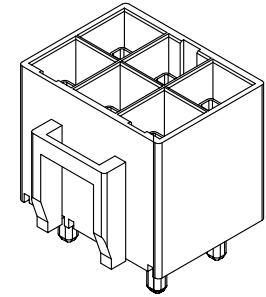

ISOMETRIC VIEW

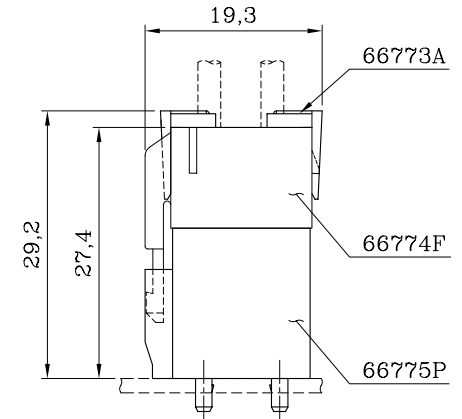
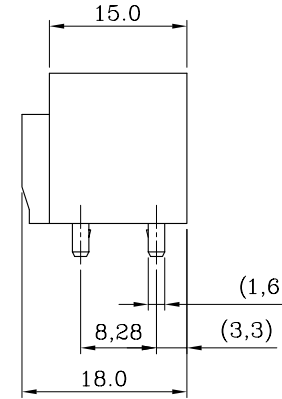

ASSEMBLY LAYOUT



Sales Drawing



聯盈電子股份有限公司  
 LANDWIN ELECTRONIC CORP.

MATERIAL: SEE NOTES		FINISH(COLOR): SEE NOTES	
W1	NEW RELEASE	31-DEC-14'	ANGULAR ±3°
REV.	REVISION RECORD	DATE	

GENERAL TOLERANCE:	PROJECTION	SCALE	UNIT	SHEET NO.	REV
	⊕	FREE	MM	1 / 1	W1
	DRAWN	R.G.	DRAW NO.		
	CHECKED	J.L.Lin	(CQ) 66775PXXBXT		
	APPD	H.Y.Lin	TITLE:		
			6.2 PITCH DUAL-ROW S/T DIP HEADER (TYPE-B)		