

ORDER INFORMATION AND DIMENSION:

Circuits	Part No. (Matte tin, white color)	Dimension	
		A	B
10	2071P10D3T	8.0	12.0
12	2071P12D3T	10.0	14.0
14	2071P14D3T	12.0	16.0
16	2071P16D3T	14.0	18.0
18	2071P18D3T	16.0	20.0
20	2071P20D3T	18.0	22.0
22	2071P22D3T	20.0	24.0
24	2071P24D3T	22.0	26.0
26	2071P26D3T	24.0	28.0
28	2071P28D3T	26.0	30.0
30	2071P30D3T	28.0	32.0
32	2071P32D3T	30.0	34.0
34	2071P34D3T	32.0	36.0
36	2071P36D3T	34.0	38.0
38	2071P38D3T	36.0	40.0
40	2071P40D3T	38.0	42.0

DESCRIPTION OF ORDER NO.:

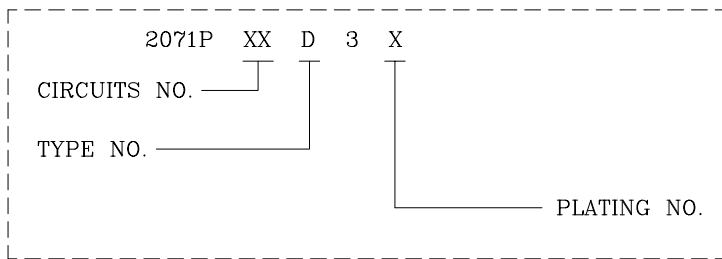

NOTES:

- MATERIAL:  
BASE: GLASS-FILLED P.B.T. 94V-0, WHITE COLOR (NATURAL)  
CONTACT PIN: BRASS
- MATES WITH 2070S DUAL-ROW TYPE-D PLUG HOUSING.
- DESCRIPTION OF COLOR CODE:  
LEGEND: 2071PXXD3X-X(-X: COLOR CODE)  
B=BLACK, C=COCONUT BROWN, E=BLUE, H=GRAY,  
I=BRICK RED, M=GREEN, R=RED, W=BROWN
- REPLACEMENT OF HALOGEN-FREE PRODUCT:  
LEGEND: 2071PXXD3X-XNH (NH: HALOGEN-FREE)  
LEGEND: 2071PXXD3X-SNH (S=NATURAL COLOR)

DESCRIPTION OF PLATING CODE

T	MATTE TIN-PLATED	1	GOLD FLASH-PLATED
---	------------------	---	-------------------

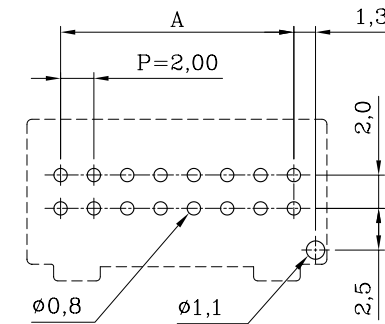
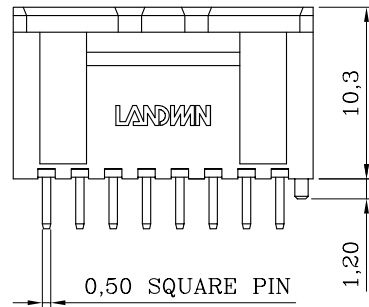
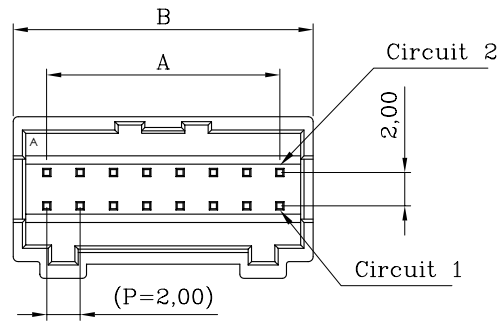

P.C. BOARD LAYOUT

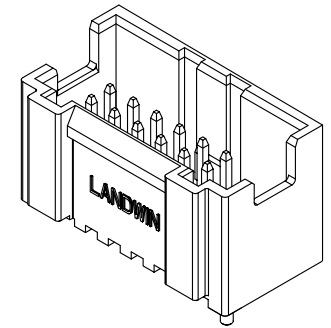

ISOMETRIC VIEW

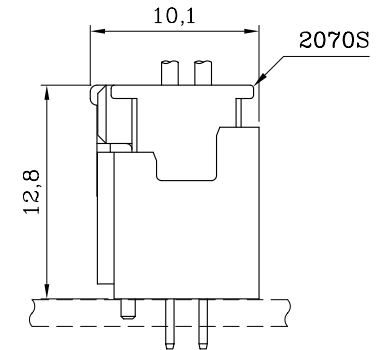
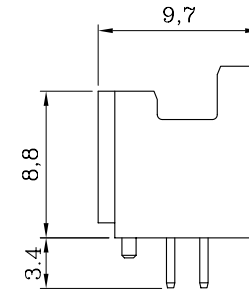

ASSEMBLY LAYOUT



Sales Drawing

**LANDWIN** 聯盈電子股份有限公司  
LANDWIN ELECTRONIC CORP.

MATERIAL: SEE NOTES		FINISH(COLOR): SEE NOTES	
W1	NEW RELEASE	31-DEC-14'	ANGULAR ±3°
REV.	REVISION RECORD	DATE	

GENERAL TOLERANCE:	PROJECTION	SCALE	UNIT	SHEET NO.	REV
	⊕	FREE	MM	1 / 1	W1
	DRAWN	R.G.	DRAW NO.		
	CHECKED	J.L.Lin	(CQ) 2071PXXD3X		
	APPD	H.Y.Lin	TITLE:		
	DATE	31-DEC-14'	2.00 PITCH DUAL-ROW TYPE-D S/T DIP-HEADER		