

ORDER INFORMATION AND DIMENSION:

Circuits	Part No. (Matte tin, White color)	Dimension	
		A	B
20	2071P20D3T-SB	18.0	23.4
28	2071P28D3T-SB	26.0	31.4

DESCRIPTION OF ORDER NO.:

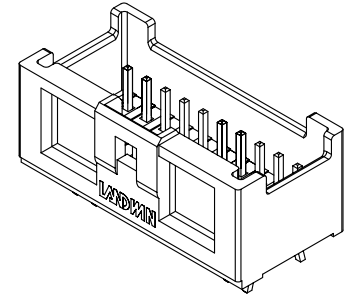
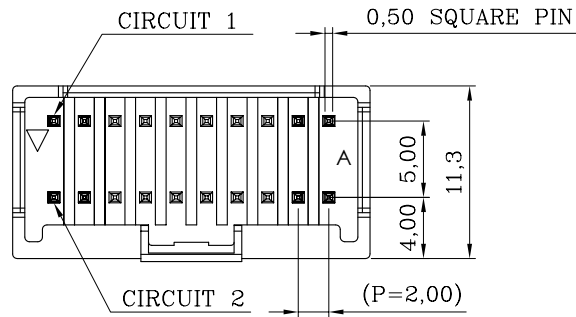
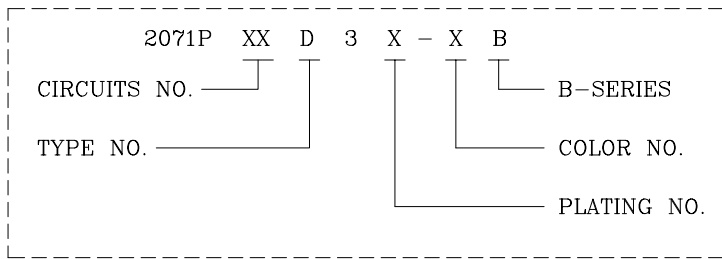

ISOMETRIC VIEW

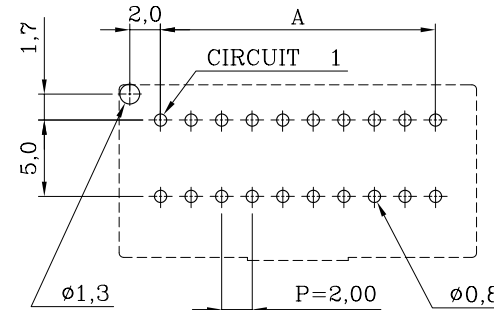
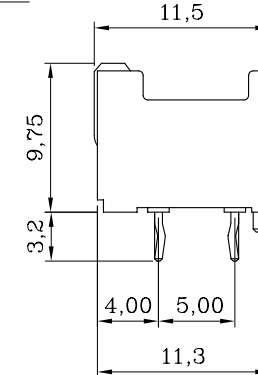
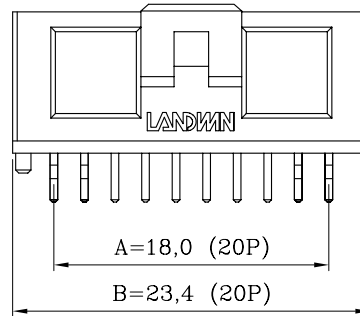

P.C. BOARD LAYOUT

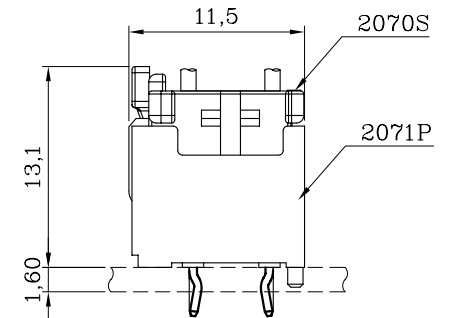

ASSEMBLY LAYOUT

NOTES:

- MATERIAL:  
BASE: GLASS-FILLED P.B.T. 94V-0  
CONTACT PIN: BRASS
- MATES WITH 2070S DUAL-ROW B-SERIES PLUG HOUSING.
- DESCRIPTION OF COLOR CODE:  
LEGEND: 2071PXXD3X-XB (-X: COLOR CODE)  
B=BLACK, C=COCONUT BROWN, E=BLUE, H=GRAY,  
I=BRICK RED, M=GREEN, R=RED, W=BROWN  
S=WHITE (NATURAL)
- REPLACEMENT OF HALOGEN-FREE PRODUCT:  
LEGEND: 2071PXXD3X-XBNH (NH: HALOGEN-FREE)

DESCRIPTION OF PLATING CODE

T	MATTE TIN-PLATED	1	GOLD FLASH-PLATED
---	------------------	---	-------------------



Sales Drawing

**LANDWIN** 聯盈電子股份有限公司  
LANDWIN ELECTRONIC CORP.

MATERIAL: SEE NOTES		PROJECTION		SCALE	UNIT	SHEET NO.	REV
FINISH(COLOR): SEE NOTES		FREE		FREE	MM	1 / 1	W1
		DRAWN		R.G.	DRAW NO.		
		CHECKED		J.L.Lin	(CQ) 2071PXXD3X-XB		
		APPD		H.Y.Lin	TITLE:		
W1	NEW RELEASE	31-DEC-14'	ANGULAR ±3°	DATE 31-DEC-14'	2.00 PITCH DUAL-ROW B-SERIES S/T DIP-HEADER		
REV.	REVISION RECORD	DATE					