

ORDER INFORMATION AND DIMENSION:

Circuits	Part No. (White color, T/P)	Dimension	
		A	B
2	2532P0200T	2.5	7.5
3	2532P0300T	5.0	10.0
4	2532P0400T	7.5	12.5
5	2532P0500T	10.0	15.0
6	2532P0600T	12.5	17.5
7	2532P0700T	15.0	20.0
8	2532P0800T	17.5	22.5
9	2532P0900T	20.0	25.0
10	2532P1000T	22.5	27.5
11	2532P1100T	25.0	30.0
12	2532P1200T	27.5	32.5
13	2532P1300T	30.0	35.0
14	2532P1400T	32.5	37.5
15	2532P1500T	35.0	40.0

DESCRIPTION OF ORDER NO.:

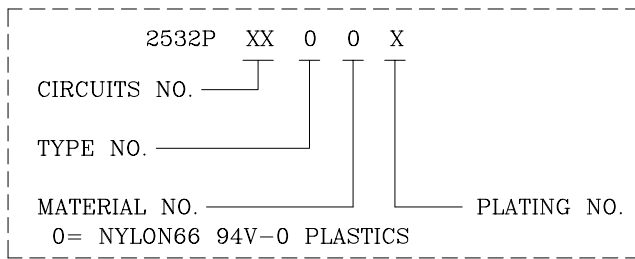

NOTES:

- MATERIAL:
BASE: NYLON66 94V-0, WHITE COLOR (NATURAL)
CONTACT PIN: BRASS
- MATES WITH 2530S SINGLE-ROW SERIES PLUG HOUSING.
- DESCRIPTION OF COLOR CODE:
LEGEND: 2532PXX00X-X (-X: COLOR CODE)
B=BLACK, C=COCONUT BROWN, D=ORANGE, E=BLUE, H=GRAY,
I=BRICK RED, K=PURPLE, L=LEMON YELLOW, M=GREEN,
P=PINK, R=RED, V=LAVENDER, W=BROWN, Y=YELLOW
- INFORMATION IN THIS DRAWING IS NOT CONSIDERED AS FINAL.

DESCRIPTION OF PLATING CODE:

T= TIN-PLATED (T/P)	1= GOLD FLASH-PLATED
V= MATTE TIN-PLATED	

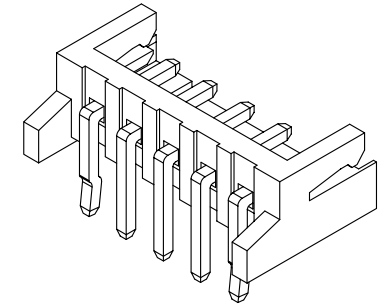
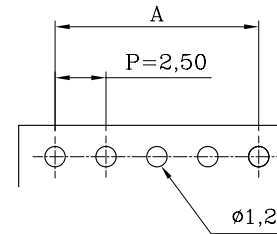
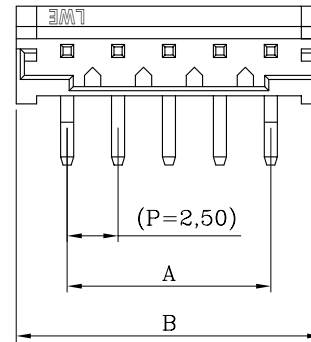
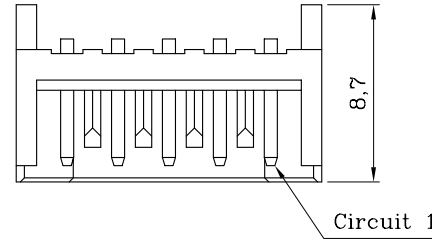

ISOMETRIC VIEW

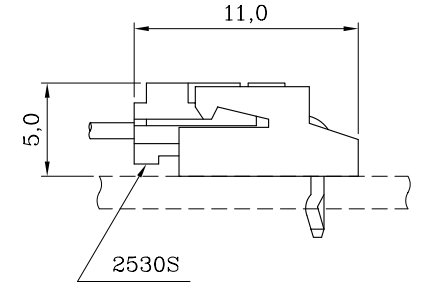
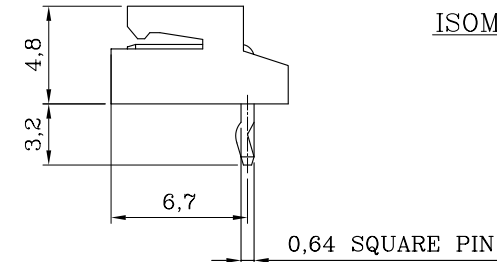

ASSEMBLY LAYOUT

P.C. BOARD LAYOUT (COMPONENT SIDE)

MATERIAL: SEE NOTES	
FINISH(COLOR): SEE NOTES	
W1	NEW RELEASE
REV.	REVISION RECORD
	DATE

		Sales Drawing			
聯盈電子股份有限公司 LANDWIN ELECTRONIC CORP.					
GENERAL TOLERANCE:	PROJECTION	SCALE	UNIT	SHEET NO.	REV
		FREE	MM	1 / 1	W1
	DRAWN R.G.	DRAW NO.			
	CHECKED J.L.Lin	(CQ) 2532PXX00X			
	APPD H.Y.Lin	TITLE:			
	W1	NEW RELEASE	31-DEC-14'	ANGULAR ±3°	DATE 31-DEC-14'
	REV.	REVISION RECORD	DATE		2.50 PITCH SINGLE-ROW RIGHT-ANGLE DIP-HEADER